

# ROLLER LED BARS



## Features

- Powered by high output 3030 LED.
- Constant Voltage.
- Diamondback 170° optic lens.
- 10 pcs per roll.
- CE, RoHS, UL, TUV, BIS, CB and LM-80 certified.

## Application

- Apply to 4–15cm depth single-sided light box at airports, metros, banks, buildings and shopping malls, etc.

## Parameters

Items	Parameters	
Part Number	YF06GA1-48-F0	YF12GA1-96-F0
CCT (K)	7000	7000
Beaming Angle (°)	170°	170°
CRI (Ra)	≥70	≥70
Luminous Flux (lm)	600	1200
Voltage (V)	DC12/24	DC12/24
Power (W)	6	12
Driving Method	Constant Voltage	Constant Voltage
Dimension (mm)	480*20*10	960*20*10
Working Tem. (°C)	-25 ~ +60	-25 ~ +60
Storage Tem. (°C)	-25 ~ +70	-25 ~ +70
Protection Grade	IP65	IP65

## Dimension

Unit: mm

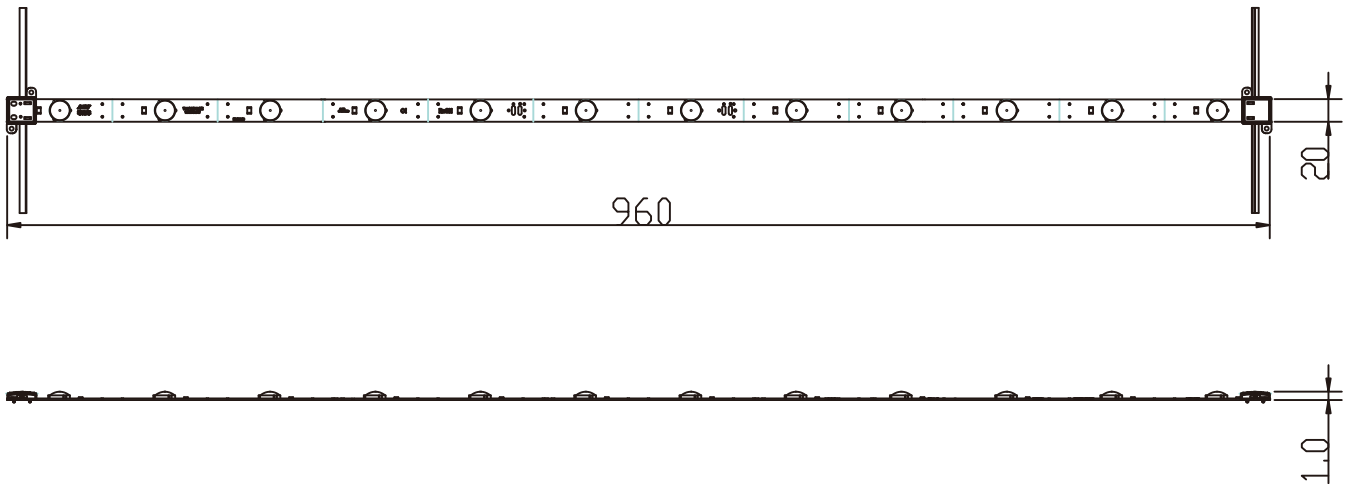

## Beaming Angle

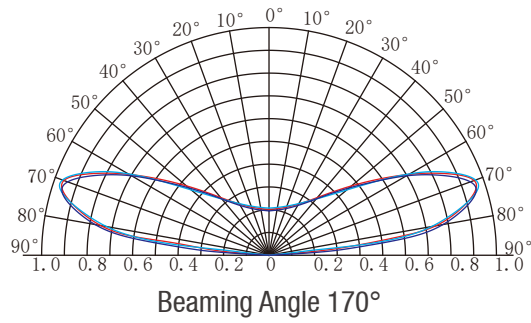

## Reference Scheme

Part Number	Depth(mm)	Distance(mm)	Density(pcs/m <sup>2</sup> )	Illumination(lux)
YF12GA1-96-F0	Dz=40	Dx=100 Dy=100	10	2500-2800
	Dz=60	Dx=100 Dy=100	10	2000-2300
	Dz=80	Dx=100 Dy=100	10	1700-1900
	Dz=100	Dx=100 Dy=100	10	1500-1700

### Remark :

01. The transmittance of the advertising fabric was 56%.
02. The above data is for reference only.

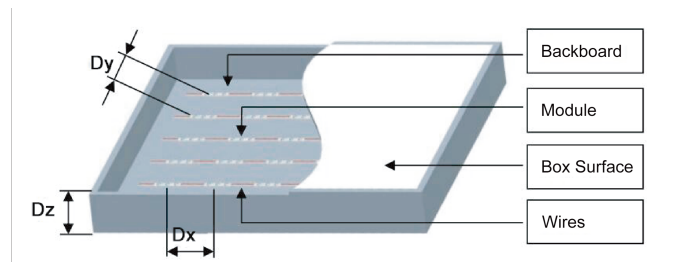

## Wire Connection

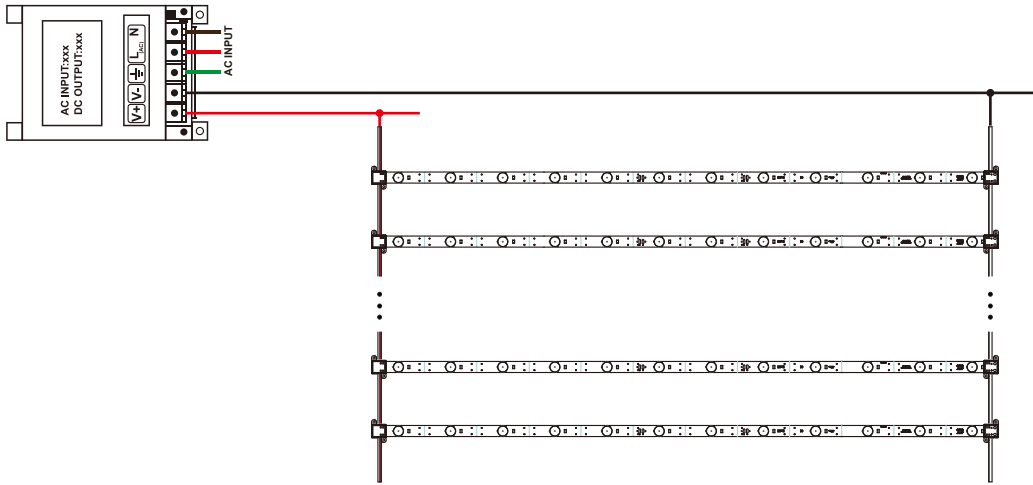

## Packing

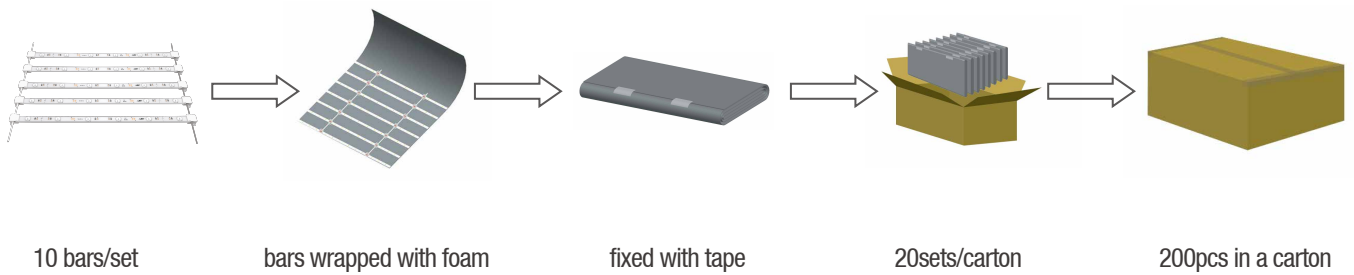

## Packing Specification

- Antistatic bag adopted
- Packing information

Part Number	YF12GA1-96-F0
Carton Dimension(mm)	1030*250*175
Package	10bars/set, 20sets/carton
Quantity Per Carton(pcs)	200
Net Weight(kg)	24.5(1±10%)
Gross Weight(kg)	25.5(1±10%)

Due to the packing manner difference, please adhere to the original products in case of discrepancy found between the picture and actual product.

## Self-provided tools & material

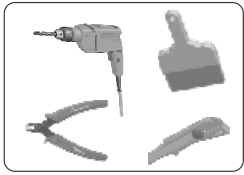

Dust brush, cutter, pencil, wire stripper, and drill

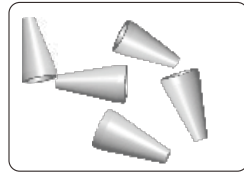

Wire Connector ( Standard)

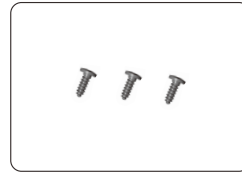

Screw

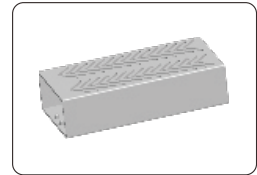

Power Supply

## Installation Guidance

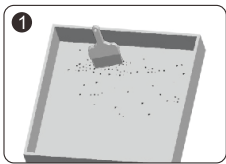

- Clean inside the light box.

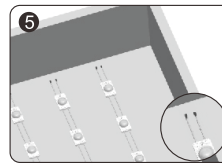

- Strip the end wire for 10mm and cap with the wire connector. Waterproof and anti-corrosion must be done on the connectors.

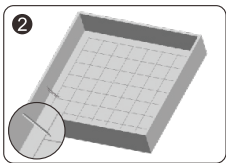

- Determine the appropriate layout.

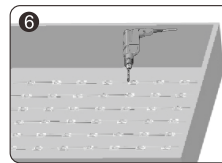

- Locate modules in the optimal position and secure with screws or neutral glass cement, which should be applied at the edge of the modules.

⚠ Note: Avoid breaking the module and wire when fixing with a drill.

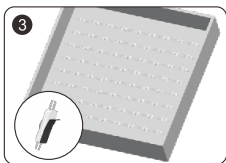

- Peel tape backing and stick modules into place.

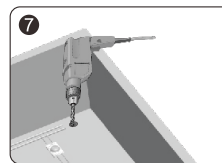

- Drill a hole for connecting power cable. Fixation and protection for the cable must be done on the hole.

⚠ Note: Avoid breaking the light box in drilling the hole.

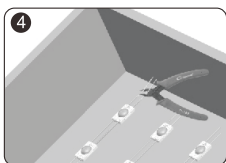

- Remove the unneeded modules.
- ⚠ Note: Cut in the middle position of the wires between modules.

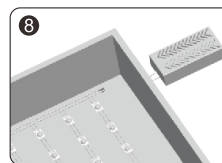

- Connect to the power cable and make sure that the polarity for connection is correct.

⚠ Note: Red wire is positive and black wire is negative.

## Instructions

01. Disassembling or modifying the product is not allowed.
02. Installation with power on is not allowed.
03. Any organic solvent chemical is not allowed.
04. Acidic or alkaline adhesive is not allowed when install, neutral glass cement could be used for installation purpose, make it drying in open environment for four hours.
05. Isolation and corrosion prevention on all wiring points and wire ends.
06. Make sure the power wire is thick enough and ensure the voltage and connections are connected correctly before power on.
07. This product should be used in a sign, do not expose it in opening site.
08. Installation, maintaining should be done by professional staff.
09. 10 bars in a serial connection maximum.
10. The power wire between power supply and module should be less than two meters to keep the same brightness on all parts.
11. Fix the bars with screws.

## Declaration

01. Warranty: 3 years.
02. In order to ensure the safety, the broken wires need to be replaced by the manufacturer or the service agent, or by the staff with the similar qualification.
03. The given data in the specification was based on the laboratory testing, there may be discrepancy found in the actual products.
04. The given drawings in the specification are only for reference, there may be discrepancy found in the actual products.
05. The products are subject to change without prior notification.



## SHENZHEN LINGBENYANG IND. CO., LTD.

Tel: +86-755-83544570      E-mail: [info@lbyled.com](mailto:info@lbyled.com)      Http://: [www.lbyled.com](http://www.lbyled.com)  
Company Address.: 28F, Luban Building, Hongli West Road, Futian District, Shenzhen 518034, China  
Factory Address: 3F, 4F and 6F, Buiding A&B Xinyongfeng Industrial Area, Yingrenshi Village,  
Shiyan Town, Bao'an District, Shenzhen 518108, China